

Modular reducing valves type HG, KG, JPG-2 and JPG-3

spool type, ISO 4401 sizes 06, 10, 16 and 25

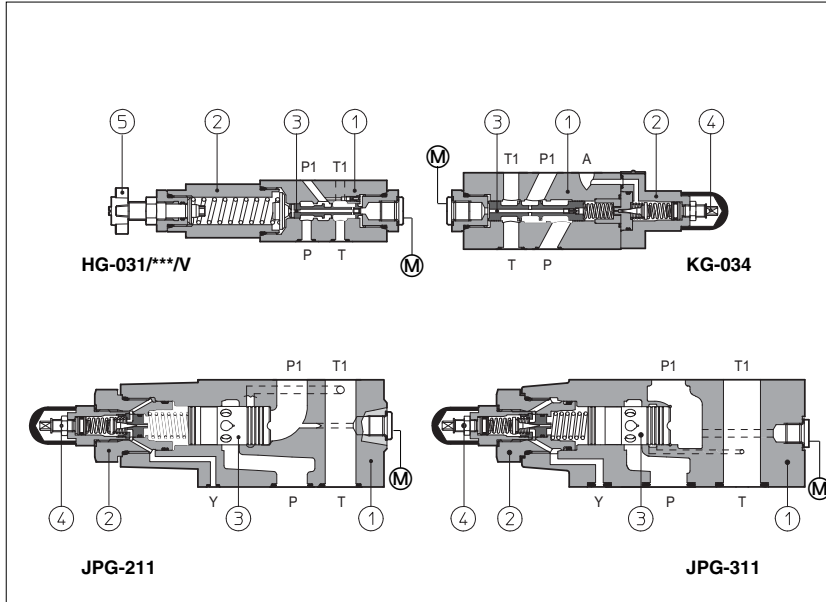

HG, KG, JPG are pressure reducing valves, spool type (3), designed to operate in oil hydraulic systems.

HG are direct, three way valves;

KG are double stage (1) (2), three way valves;

JPG are double stage (1) (2), two way valves.

Pressure adjustment is operated by loosening the locking nut and turning the setting screw (4) in the normal model.

Optional versions with a handwheel (5) are available on request.

Clockwise rotation increases the pressure.

HG = ISO 4401 size 06 interface: flow up to 50 l/min; pressure adjustment up to 210 bar.

KG = ISO 4401 size 10 interface: flow up to 100 l/min; pressure adjustment up to 210 bar.

JPG-2 = ISO 4401 size 16 interface: flow up to 250 l/min; pressure adjustment up to 210 bar.

JPG-3 = ISO/4401 size 25 interface: flow up to 300 l/min; pressure adjustment up to 210 bar.

Valves designed to operate in hydraulic systems with hydraulic mineral oil or synthetic fluid having similar lubricating characteristics.

1 MODEL CODE

HG-0

Modular pressure reducing valve, size:

- HG-0** = 06
- KG-0** = 10
- JPG-2** = 16
- JPG-3** = 25

Configuration, see section 2

two way (only for JPG):

11 = reduced pressure on P port

Note: JPG is available only in configuration 11

31

three way (only for HG-0 and KG-0):

31 = reduced pressure on P port

33 = reduced pressure on A port

34 = reduced pressure on B port

/ 210

Pressure range for HG

32 = 3 - 32 bar

50 = 2 - 50 bar

75 = 10 - 75 bar

100 = 20 - 100 bar

210 = 50 - 210 bar

/V

Options:

V = setting adjustment by handwheel instead of a grub screw protected by cap

Only for HG:

/VF = regulating knob

/VFS = regulating knob with safety locking

Series number

/*

Synthetic fluids:

WG = water glycol

PE = phosphate ester

Pressure range for KG

100 = 7 - 100 bar

210 = 8 - 210 bar

Pressure range for JPG

100 = 6 - 100 bar

210 = 70 - 210 bar

2 HYDRAULIC CHARACTERISTICS

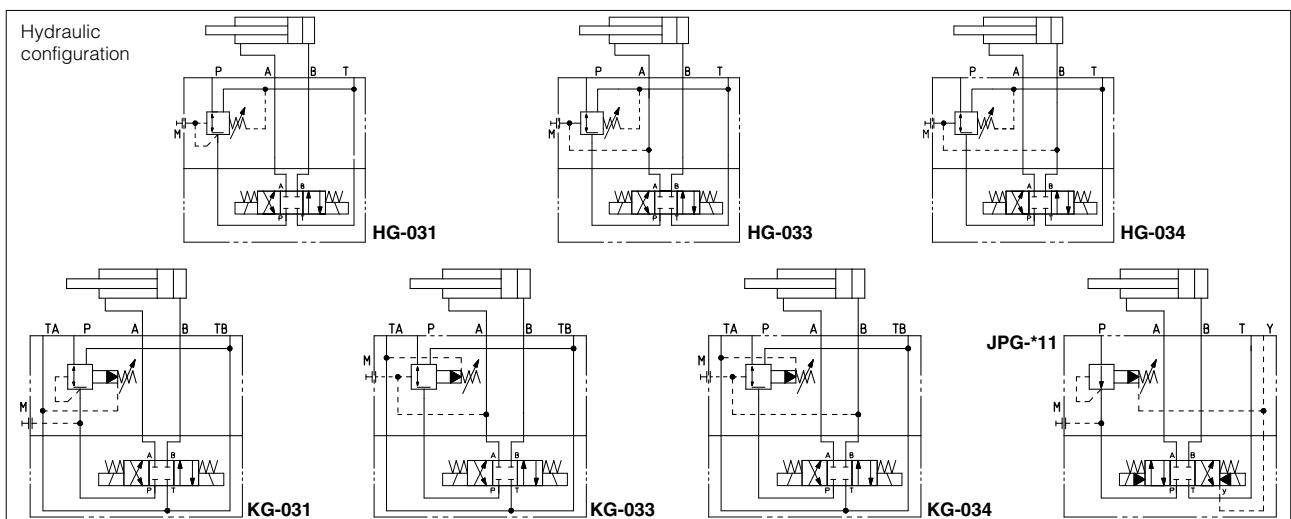

Valve model	HG-03*/32	HG-03*/50	HG-03*/75	HG-03*/100	HG-03*/210	KG-03*/100	KG-03*/210	JPG-211/100	JPG-211/210	JPG-311/100	JPG-311/210
Max flow [l/min]	50					100		250		300	
Pressure range [bar]	3 ÷ 32	2 ÷ 50	10 ÷ 75	20 ÷ 100	50 ÷ 210	7 ÷ 100	8 ÷ 210	6 ÷ 100	70 ÷ 210	6 ÷ 100	70 ÷ 210
Max inlet pressure [bar]	350					315		315		315	
Max pressure on port T [bar]	160					160		160		160	

3 MAIN CHARACTERISTICS OF MODULAR PRESSURE REDUCING VALVES TYPE HG, KG, JPG

Assembly position	Any position. Note: JPG cannot be associated with directional valves having hydraulic centring device (/M) because JPG don't have L drain port.
Subplate surface finishing	Roughness index $\sqrt{0.4}$, flatness ratio 0,01/100 (ISO 1101)
Ambient temperature	-20°C to +70°C
Fluid	Hydraulic oil as per DIN 51524 ... 535; for other fluids see section I
Recommended viscosity	15 ÷ 100 mm ² /s at 40°C (ISO VG 15 ÷ 100)
Fluid contamination class	ISO 19/16, achieved with in line filters at 25 µm value and $\beta_{25} \geq 75$ (recommended)
Fluid temperature	-20°C +60°C (standard and /WG seals) -20°C +80°C (/PE seals)

4 DIAGRAMS OF HG-03* based on mineral oil ISO VG 46 at 50°C

- 1** = regulated pressure variation versus flow:
- between use port and discharge port
- between inlet port and use port
- 2** = differential pressure variation versus flow between inlet port and use port
- 3** = differential pressure variation versus flow between use port and discharge port

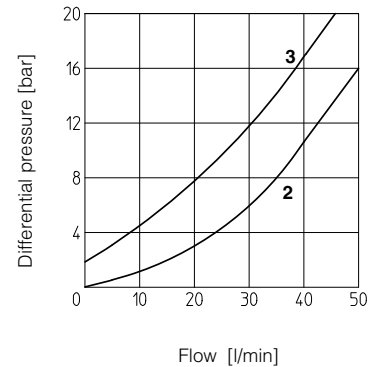
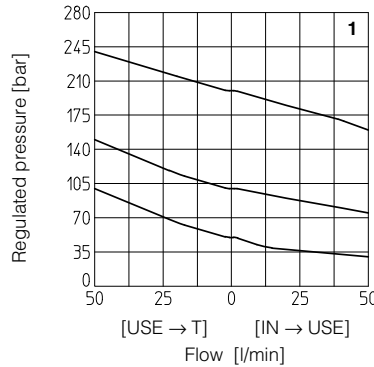

5 DIAGRAMS OF KG-03* based on mineral oil ISO VG 46 at 50°C

- 1** = regulated pressure variation versus flow:
- between use port and discharge port
- between inlet port and use port
- 2** = differential pressure variation versus flow between inlet port and use port
- 3** = differential pressure variation versus flow between use port and discharge port

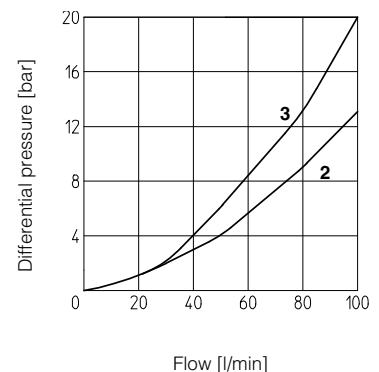
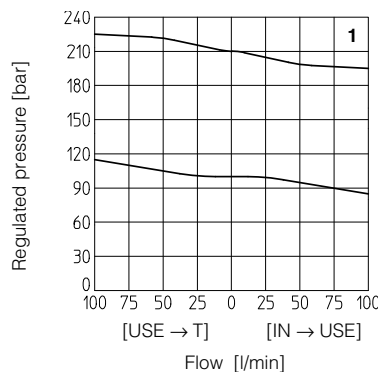

6 DIAGRAMS OF JPG-211 based on mineral oil ISO VG 46 at 50°C

- 1** = regulated pressure variation versus flow between inlet port and use port
- 2** = differential pressure variation versus flow between use port and discharge port

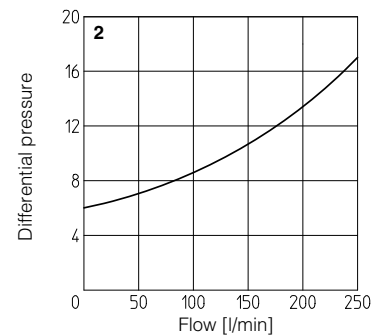
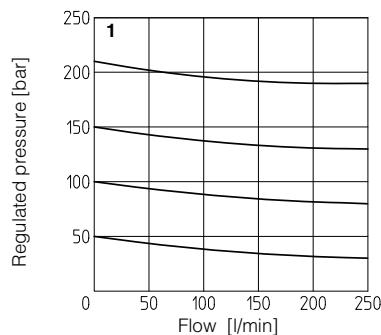

7 DIAGRAMS OF JPG-311 based on mineral oil ISO VG 46 at 50°C

- 1** = regulated pressure variation versus flow between inlet port and use port
- 2** = differential pressure variation versus flow between use port and discharge port

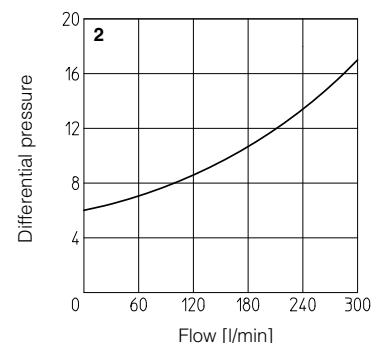
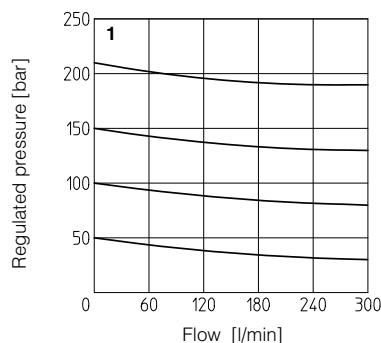

8 INSTALLATION DIMENSIONS OF HG-0 VALVES [mm]

HG-03*

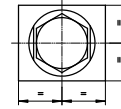
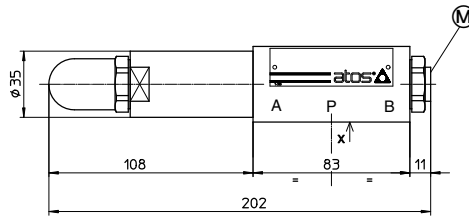
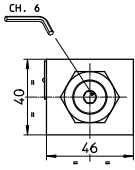

Ⓜ = Pressure gauge port = G 1/4"

Adjustment device for option /V

Mass: 2,3 Kg

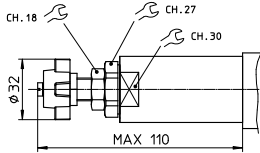

Adjustment device for option /VF and /VS

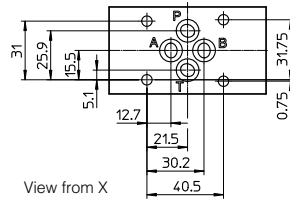
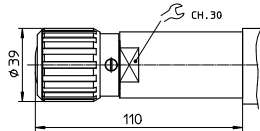

ISO 4401: 2005

Mounting surface: 4401-03-02-0-05

Diameter of ports A, B, P, T: $\varnothing = 7,5$ mm

Seals: 4 OR 108

Fastening bolts: n° 4 socket head screws M5. The length depends on number and type of modular elements associated.

9 INSTALLATION DIMENSIONS OF KG-0 VALVES [mm]

KG-03*

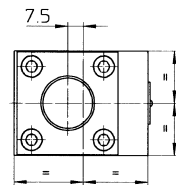
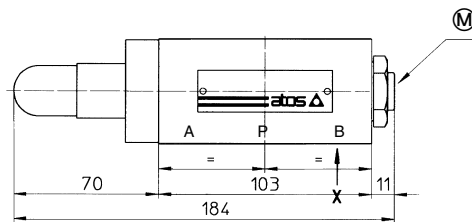
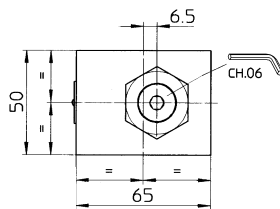

Ⓜ = Pressure gauge port = G 1/4"

Mass: 3,8 Kg

Adjustment device for option /V

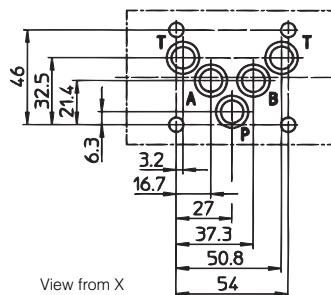
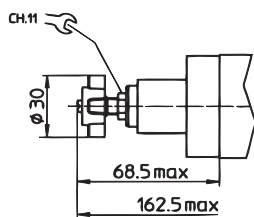

ISO 4401: 2005

Mounting surface: 4401-05-04-0-05

Diameter of ports A, B, P, T: $\varnothing = 11,2$ mm

Seals: 5 OR 2050

Fastening bolts: n° 4 socket head screws M6. The length depends on number and type of modular elements associated.

10 INSTALLATION DIMENSIONS OF JPG-2 VALVES [mm]

JPG-211

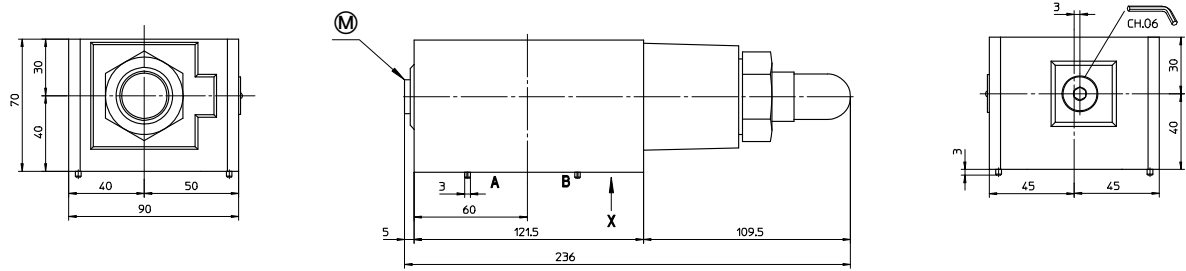

Ⓜ = Pressure gauge port = G 1/4"

Mass: 9 Kg

Adjustment device for option /V

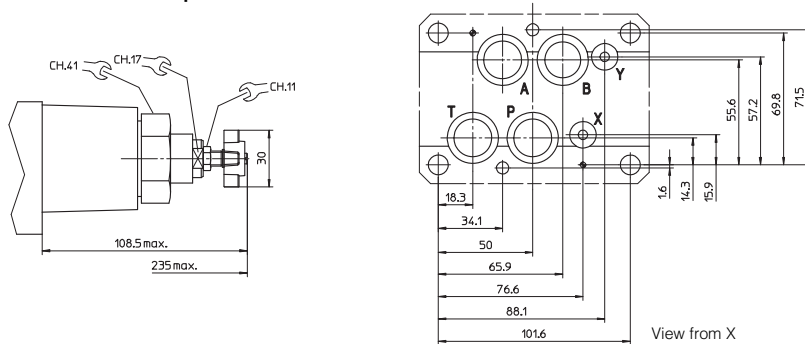

ISO 4401: 2005
Mounting surface: 4401-07-07-0-05
 Diameter of ports A, B, P, T: $\varnothing = 20$ mm
 Diameter of ports X, Y: $\varnothing 7$ mm
 Seals: 4 OR 130: 2 OR 109

Fastening bolts: n° 4 socket head screws M10 and n° 2 M6. The length depends on number and type of modular elements associated.

11 INSTALLATION DIMENSIONS OF JPG-3 VALVES [mm]

JPG-311

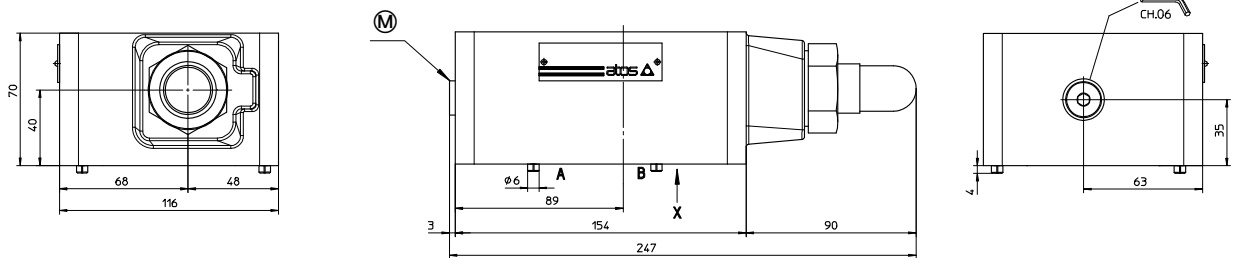

Ⓜ = Pressure gauge port = G 1/4"

Mass: 9 Kg

Adjustment device for option /V

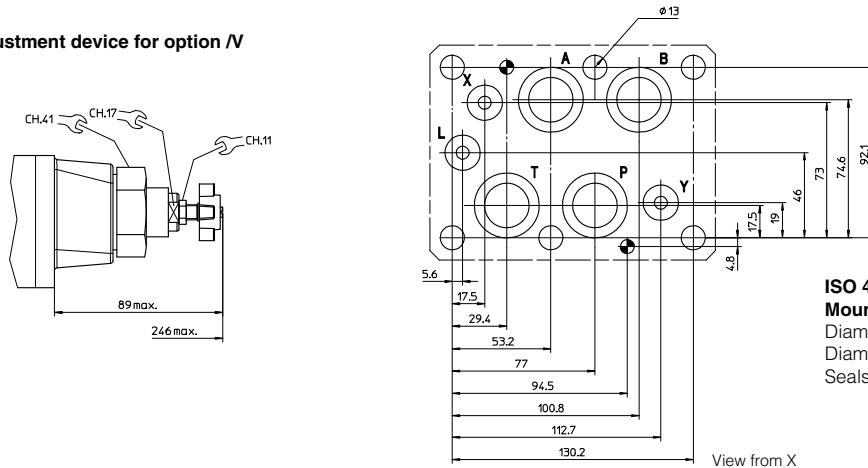

ISO 4401: 2005
Mounting surface: 4401-08-08-0-05
 Diameter of ports A, B, P, T: $\varnothing = 24$ mm
 Diameter of ports X, Y: $\varnothing 7$ mm
 Seals: 4 OR 130: 2 OR 109

Fastening bolts: n° 6 socket head screws M12. The length depends on number and type of modular elements associated.