

# Solenoid directional valves type DLOH, DLOK

poppet type leak free, direct operated, ISO 4401 size 06

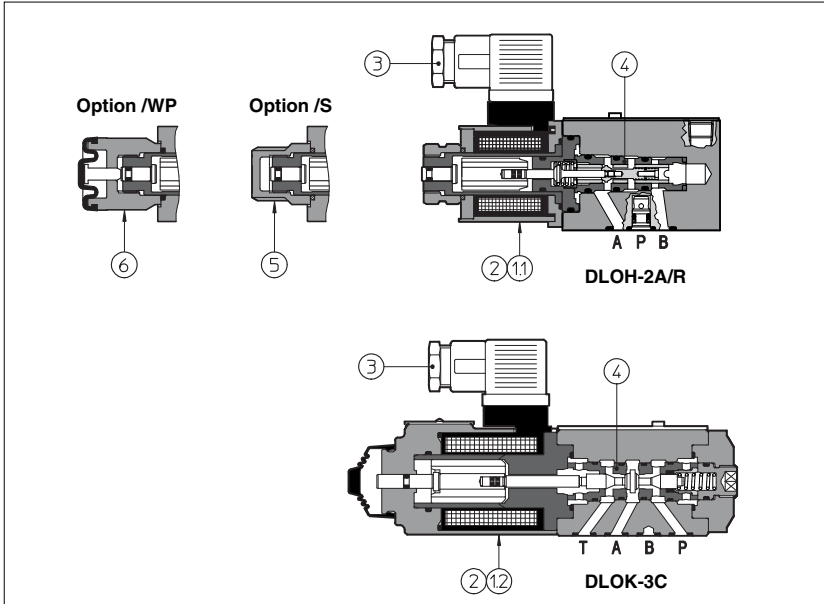

DLOH and DLOK are poppet type, two or three way, two position direct operated solenoid valves, designed to operate in oil hydraulic systems when leak free is required.

They are operated by wet type solenoids type OLU (11) and OLK (12) with coils certified according to the North American standard **CUR US**.

The DLOH are available with optional manual prolonged override, protected by a rubber cap (6), option /WP (standard for DLOK).

Moving parts are protected, lubricated and cushioned in oil.

Standard dimensions cartridge construction allows a wide variety of configurations only by easy replacement of the cartridge itself (4).

Cartridges of DLOH are available also as loose parts for mounting in the manifolds, see (10).

They can be supplied with optional devices for control of switching times.

Standard electric/electronic connectors (3) able to satisfy the requirements of modern machines for electric interfaces characteristics.

The coils (2) are fully encapsulated (class H) and for DLOH are easily replaceable without the aid of tools.

Rugged execution suitable for outdoor use.

**Surface mounting: ISO 4401 size 06.**  
**Max flow up to 12 l/min (DLOH) and 30 l/min (DLOK).**  
**Max pressure: 350 bar for DLOH 315 bar for DLOK**

## 1 MODEL CODE

<b>DLO</b>	<b>H - 2</b>	<b>A</b>	<b>/WP - U</b>	<b>X</b>	<b>24DC</b>	<b>**</b>	<b>/*</b>
Directional control valve poppet type size 06	H = max flow: 12 l/min K = max flow: 30 l/min						Synthetic fluids: WG = water-glycol PE = phosphate ester
	2 = two way (only DLOH) 3 = three way					Series number	
Valve configuration, see table (2): A = open in resting position C = closed in resting position					Voltage code, see section (5): 00 = solenoid valve without coils		
Options: /WP = prolonged manual override protected by rubber cap (only DLOH) /R = with check valve on port P, see (2) (only DLOH) /S = no hand operation and poppet overlapping during the intermediate position for safety applications (only DLOH) /L1, /L2, /L3 = device for controlling switching time. Not available for valves with electronic connectors				X = without connector See section (4) for available connectors, to be ordered separately			
				- O = solenoid OLK for DC supply (only for DLOK) - U = solenoid OLU for DC supply (only for DLOH)			

## 2 VALVE CONFIGURATION

<b>DLOH-2A</b>	<b>DLOH-2A/R</b>	<b>DLOH-2C</b>	<b>DLOH-2C/R</b>	<b>DLOK-3A</b>
<b>DLOH-3A</b>	<b>DLOH-3A/R</b>	<b>DLOH-3C</b>	<b>DLOH-3C/R</b>	<b>DLOK-3C</b>

### 3 MAIN CHARACTERISTICS OF DIRECTIONAL VALVES TYPE DLOH, DLOK

Assembly position / location	Any position	
Subplate surface finishing	Roughness index $\sqrt{0.4}$ flatness ratio 0,01/100 (ISO 1101)	
Ambient temperature	from -20°C to +70°C	
Fluid	Hydraulic oil as per DIN 51524 .... 535; for other fluids see section 11	
Recommended viscosity	15 ÷ 100 mm <sup>2</sup> /s at 40°C (ISO VG 15 ÷ 100)	
Fluid contamination class	ISO 19/16, achieved with in line filters at 25 µm value and $\beta_{25} \geq 75$ (recommended)	
Fluid temperature	-20°C +60°C (standard and /WG seals) -20°C +80°C (/PE seals)	
Flow direction	As shown in the symbols of table 2	
Operating pressure	<b>DLOH</b>	Ports P, A, B: <b>350 bar</b> Port T: <b>160 bar</b>
	<b>DLOK</b>	Ports P, A, B: <b>315 bar</b> Port T: <b>160 bar</b>
Rated flow	See diagrams Q/Δp at section 4	
Maximum flow	<b>DLOH</b>	<b>12 l/min</b> see operating limits at section 7
	<b>DLOK</b>	<b>30 l/min</b> see operating limits at section 7
Internal leakage	Less than 5 drops/min ( $\leq 0,36$ cm <sup>3</sup> /min) at max working pressure	

#### 3.1 Coils characteristics

Insulation class	<b>H</b> (180°C) Due to the occurring surface temperatures of the solenoid coils, the European standards EN563 and EN982 must be taken into account
Connector protection degree	IP 65
Relative duty factor	100%
Supply voltage and frequency	See electric feature 5
Supply voltage tolerance	± 10%
Certification	<b>C UR US</b>

### 4 ELECTRIC/ELECTRONIC CONNECTORS ACCORDING TO DIN 43650

The connectors must be ordered separately

Code of connector	Function
<b>SP-666</b>	Connector IP-65, suitable for direct connection to electric supply source
<b>SP-667</b>	As SP-666 connector IP-65 but with built-in signal led, suitable for direct connection to electric supply source
<b>SP-669</b>	With built-in rectifier bridge for supplying DC coils by alternating current (AC 110V and 230V - I <sub>max</sub> 1A)

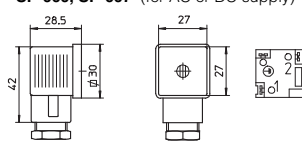
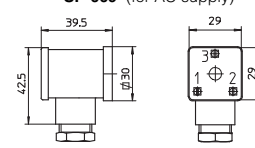
<p><b>SP-666, SP-667</b> (for AC or DC supply)</p> 		<p><b>SP-669</b> (for AC supply)</p> 	
<b>CONNECTOR WIRING</b>			
<p><b>SP-666, SP-667</b></p> <p>1 = Positive ⊕ 2 = Negative ⊖ ⊕ = Coil ground</p>		<p><b>SP-669</b></p> <p>1,2 = Supply voltage V<sub>Ac</sub> 3 = Coil ground</p>	
<b>SUPPLY VOLTAGES</b>			
<p><b>SP-666</b> All voltages</p>		<p><b>SP-667</b> 24 AC or DC 110 AC or DC 220 AC or DC</p>	
<p>110/50 AC 110/60 AC 230/50 AC 230/60 AC</p>			

## 5 ELECTRIC FEATURES

Valve	External supply nominal voltage $\pm 10\%$ (1)		Voltage code	Type of connector	Power consumption (2)	Code of spare coil	Colour of coil label
DLOH	DIRECT CURRENT	6 DC	<b>6 DC</b>	SP-666 or SP-667	33 W	SP-COU-6DC/80	brown
		12 DC	<b>12 DC</b>			SP-COUR-12DC/10	green
		24 DC	<b>24 DC</b>			SP-COUR-24DC/10	red
		48 DC	<b>48 DC</b>			SP-COU-48DC/80	silver
	ALTERNATE CURRENT	110/50 AC	<b>110/50/60 AC</b>	SP-669	40 VA	SP-COU-110RC/80	gold
		120/60 AC	<b>120/60 AC</b>		35 VA	SP-COUR-110RC/10	gold
		230/50 AC	<b>230/50/60 AC</b>		40 VA	SP-COU-230RC/80	blue
		230/60 AC	<b>230/60 AC</b>		35 VA	SP-COUR-230RC/10	blue
DLOK	DIRECT CURRENT	12 DC	<b>12 DC</b>	SP-666 or SP-667	32 W	-	-
		24 DC	<b>24 DC</b>		40 W	-	-
		110 DC	<b>110 DC</b>		-	-	-
		220 DC	<b>220 DC</b>		-	-	-
	ALTERNATE CURRENT	110/50 AC	<b>110/50/60 AC</b>	SP-669	40 VA	-	-
		120/60 AC	<b>120/60 AC</b>		35 VA	-	-
		230/50 AC	<b>230/50/60 AC</b>		40 VA	-	-
		230/60 AC	<b>230/60 AC</b>		35 VA	-	-

- (1) For other supply voltages available on request see technical table E010.  
 (2) Average values based on tests performed at nominal hydraulic condition and ambient/coil temperature of 20°C.

## 6 FLOW VERSUS PRESSURE DROP DIAGRAM based on mineral oil ISO VG 46 at 50°C

Flow direction	P → A (1)	A → T (1)
Valve type	(P → B)	(B → T)
DLOH-2A	B	-
DLOH-2C	C	-
DLOH-3A	D	C
DLOH-3C	C	A
DLOK-3A	F	E
DLOK-3C	F	E

(1) For two-way valves, pressure drop refers to P→T

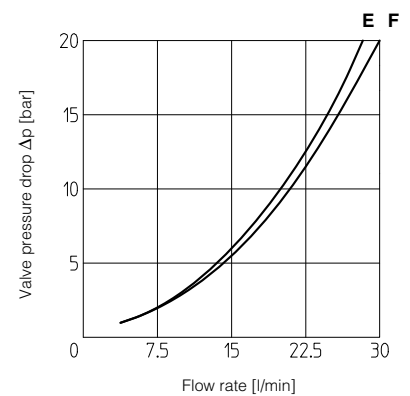
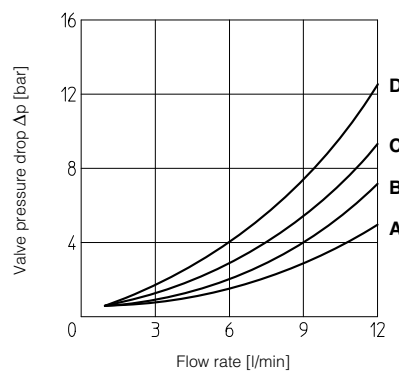

## 7 OPERATING LIMITS based on mineral oil ISO VG 46 at 50°C

The diagram has been obtained with warm solenoids and power supply at lowest value (Vnom - 10%).

A = DLOH-3A

B = DLOH-2A, DLOH-3C

C = DLOK-3A

D = DLOK-3C

Note: using E-SR/DC connector, the max operating frequency is 2 Hz.

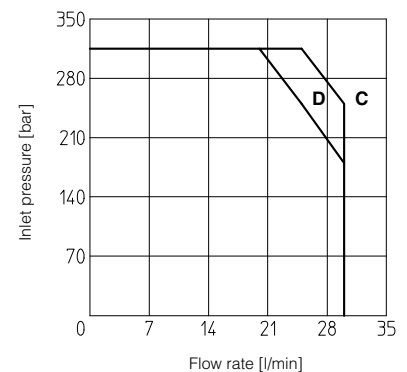
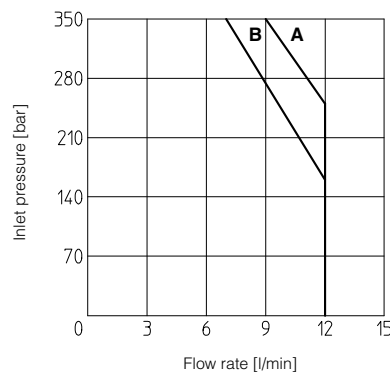

## 8 SWITCHING TIMES (average values in msec)

Valve type	Connector	Switch-on AC	Switch-on DC	Switch-off
DLO*-**	SP-666, SP-667	-	45	25
DLO*-**	SP-669	30	-	75
DLO*-**	E-SR/DC	-	45	55
DLO*-**/L1	SP-666, SP-667	-	60	60
DLO*-**/L2	SP-666, SP-667	-	80	80
DLO*-**/L3	SP-666, SP-667	-	110	150

TEST CONDITIONS:

- 8 l/min; 150 bar
- nominal voltage
- 2 bar of counter pressure on port T
- based on mineral oil ISO VG 46 at 50°C

The response time is affected by elasticity of the hydraulic circuit, by variation of hydraulic characteristics and temperature

**9 DIMENSIONS [mm]**

**DLOH-2\***  
**DLOH-2\*/R**  
**ISO 4401: 2005**  
**Mounting surface: 4401-03-02-0-05**  
**without A and B ports**  
Fastening bolts:  
4 socket head screws M5x50 class 12.9  
Tightening torque = 8 Nm  
Seals: 2 OR 108  
Ports P, T:  
Ø = 7,5 mm (max)

**Mass: 1,5 Kg**

**DLO\*-3\***  
**DLO\*-3\*/R**  
**ISO 4401: 2005**  
**Mounting surface: 4401-03-02-0-05**  
Fastening bolts:  
4 socket head screws M5x50 class 12.9  
Tightening torque = 8 Nm  
Seals: 4 OR 108  
Ports P, A, B, T:  
Ø = 7,5 mm (max)

**Mass: 1,5 Kg**

**DLOK-3\***  
**ISO 4401: 2005**  
**Mounting surface: 4401-03-02-0-05**  
Fastening bolts:  
4 socket head screws M5x50 class 12.9  
Tightening torque = 8 Nm  
Seals: 4 OR 108  
Ports P, A, B, T:  
Ø = 7,5 mm (max)

**DLOK-3C**

**Mass: 1,6 Kg**

**DLOK-3A**

**Mass: 1,6 Kg**

**P = PRESSURE PORT**  
**A = USE PORT (not used for -3C versions)**  
**B = USE PORT (not used for -3A versions)**  
**T = TANK PORT**  
For the max pressures on ports, see section 3

Overall dimensions refer to valves with connectors type SP-666

**10 INSTALLATION DIMENSIONS OF CARTRIDGES [mm]**

**LU-O2\*, cartridge of DLOH-2\***

**Note:**  
(\* ) for version /WP the height is increased by 14,5 mm

**LU-O3\*, cartridge of DLOH-3\***

**Notes:**  
The orifice B is not used by the cartridge type LU-O3A  
The orifice A is not used by the cartridge type LU-O3C  
(\* ) for version /WP the height is increased by 14,5 mm

These cartridges can be installed in the manifolds

**11 MOUNTING SUBPLATES**

Valve	Subplate model	Ports location	GAS ports	Ø Counterbore [mm]	Mass [Kg]
			A-B-P-T	A-B-P-T	
<b>DLOH-*</b> <b>DLOK-*</b>	BA-202 (1)	Ports A, B, P, T underneath;	3/8"	-	1,2
	BA-204 (1)	Ports P, T underneath; ports A, B on lateral side	3/8"	25,5	1,8
	BA-302 (1)	Ports A, B, P, T underneath;	1/2"	30	1,8

(1) The subplates are supplied with 4 fastening bolts M5x50 class 12.9; Also available multi station and modular subplates. For further details see table K280.